

Tool Box - Measurement

This function uses VMI prediction module to measure the actual waveform of the sensor and actuator, and uses simulation function to diagnose the vehicle.

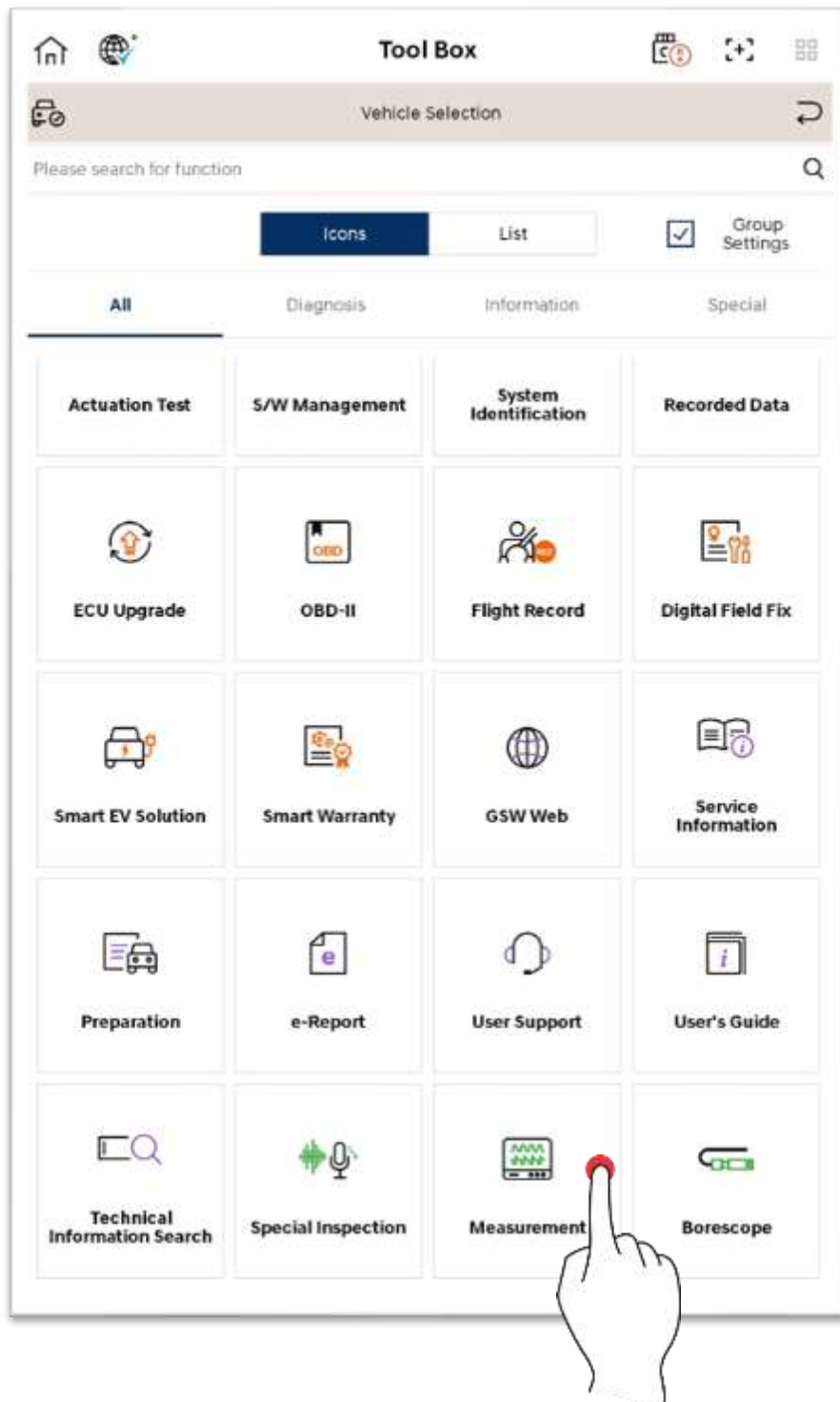

Hardware Specification

VMI Module





Role of the probe

A device that displays changes in an electrical signal as a graph, mainly showing changes in the signal over time.

To measure a signal, a probe probe connection and a ground connection are required
The probe includes a ground clip that can be connected to the ground of the circuit under test,

and when used, connect the ground clip to the ground terminal of the circuit, and then touch the probe probe to the test point

Part name	Description
 <p data-bbox="248 1261 459 1294">CABLE SCOPE</p>	<p data-bbox="687 1010 1474 1151">A basic probe used for 2 channels (single mode) or 4 channels (differential mode). (Recommended when using 4 channels)</p> <p data-bbox="687 1167 1465 1200">* It can measure both oscilloscopes and multimeters</p>
 <p data-bbox="236 1832 539 1865">CABLE SCOPE(GND)</p>	<p data-bbox="687 1514 1501 1704">One end of the probe cable is used for ground and one end is used for signal capture in 2 channels (single mode). When using a dedicated scope cable (GND), you can measure precise waveforms</p> <p data-bbox="687 1765 1350 1843">*This cable can only be used for oscilloscope measurements</p>

Probe set



Replaceable probe rod (screw-type fixing)

- Select and combine rods with diameters of 0.6, 0.8, and 1.0 m
- Components (probe/rod/storage case/driver)

[bination method]

"After assembling in the order of the picture, turn it with a driver and tighten it." (1 → 4)



Power Cable Connection

VMI uses the vehicle's battery as its power.

Use VMI battery cable to connect the cable's red part to batter (+) terminal, and its black part to (-) terminal.

VMI batter cable is insulated to prevent short circuit when connecting to the vehicle. For the convenience of use, each clip has a hole to insert the channel probe.



Caution

When connecting the power cable, be cautious to prevent the battery's polarity from being changed.

USB Cable Connection

To connect VMI with tablet, USB and OTG cables are required as shown below.

* VMI does not support wireless communication.



Caution

Do not use other USB cables apart from USB cable (P/No. G1X-----) supplied by GIT. USB connection may become unstable.

VMI Placement and Precautions

- ✓ Do not place or hang VMI main body near a light bulb.
- ✓ When connecting the channel probe to VMI main body, check the key and insert location.
- ✓ To remove SB cable, press Lock tab of USB on VMI main body, and pull the USB cable to remove it.
- ✓ When performing measurement, make sure that cables such as USB cable, DC power supply device and channel probe do not make interference with the vehicle's actuator (cooling fan, fan belt, etc.).
- ✓ Do not use 110 V or 220 V current (AC) voltage using VMI main body. It may lead to causing a serious damage to VMI.
- ✓ When using an oscilloscope, VMI's power should be supplied using the vehicle's battery.

General Specification

Item	Specification
FPGA	Intel 400Mhz (154)
MCU	STM32H743 480Mhz
ADC	TI 12Bit
DMM	Cyristek
USB	High Speed 480Mbit/s
SDRAM	256Mbit

Oscilloscope

Item	Specification
Probe channel entry	Single-ended & Differential
Universal channel measurement voltage	-1,000 ~ +1,000V (▲)
Current channel measurement	-1,000 ~ +1,000A
Decomposition ability	12 Bit
Specification (sampling)	80Ms/s

Multimeter

Item	Specification
Voltage Measurement	-1,000~ +1,000V
Resistance Measurement	0.1 ohm~10Mohm
Frequency Measurement	1Hz~100kHz

Simulation

Item	Specification
Voltage Channel Measurement	0 ~ 5V
Pulse Measurement	1.0Hz - 999Hz
Actuator Measurement	1.0Hz - 999Hz

Function Introduction

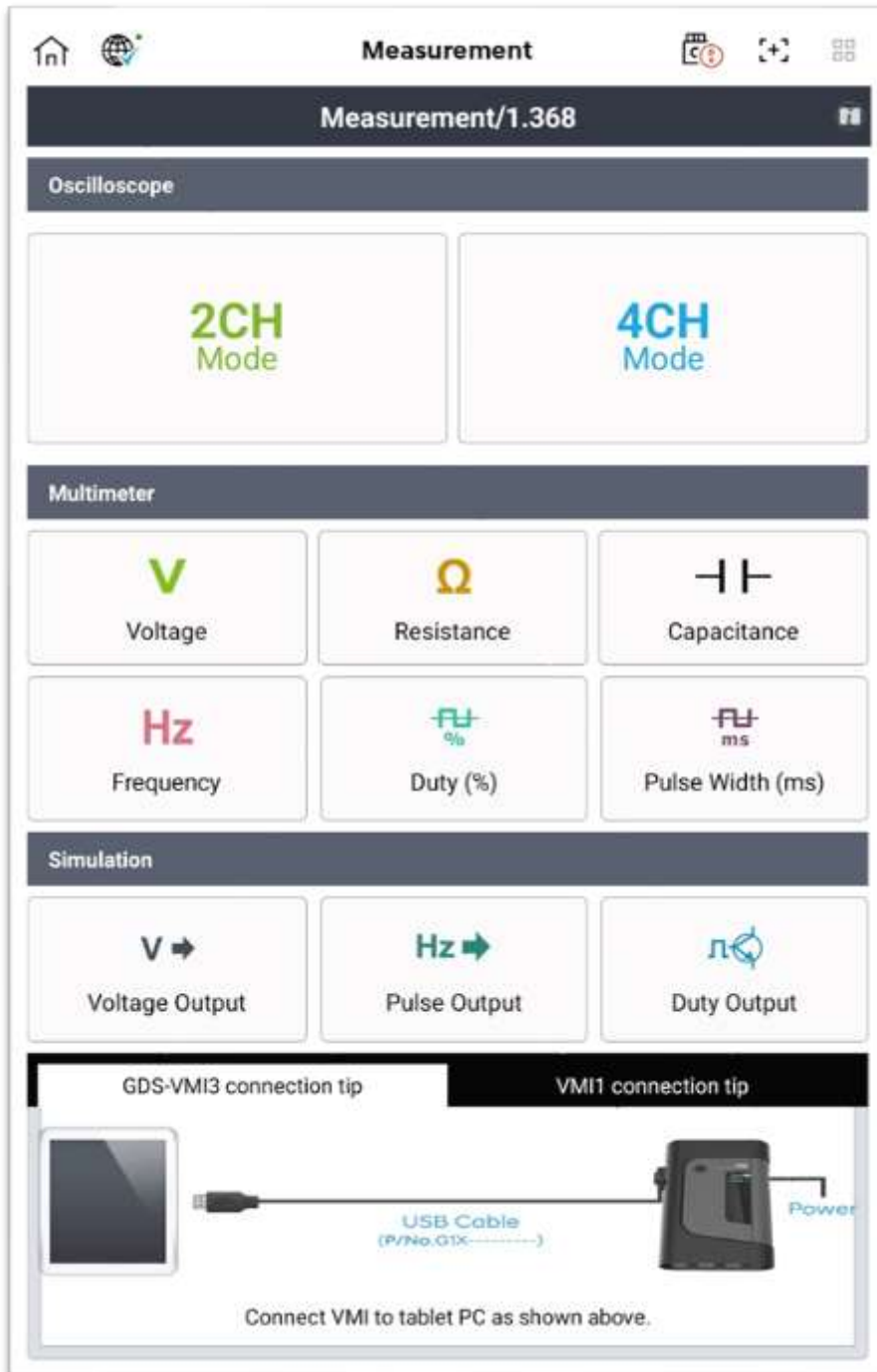

Oscilloscope

Oscilloscope function uses total of 4 channels, and 2-channel mode (ground separation) and 4-channel mode (ground common) can be used. Through the waveform measured by the channel probe, values of cursors A and B, minimum value, maximum value, average value, frequency, duty (-) and duty (+) values between A and B can be measured.

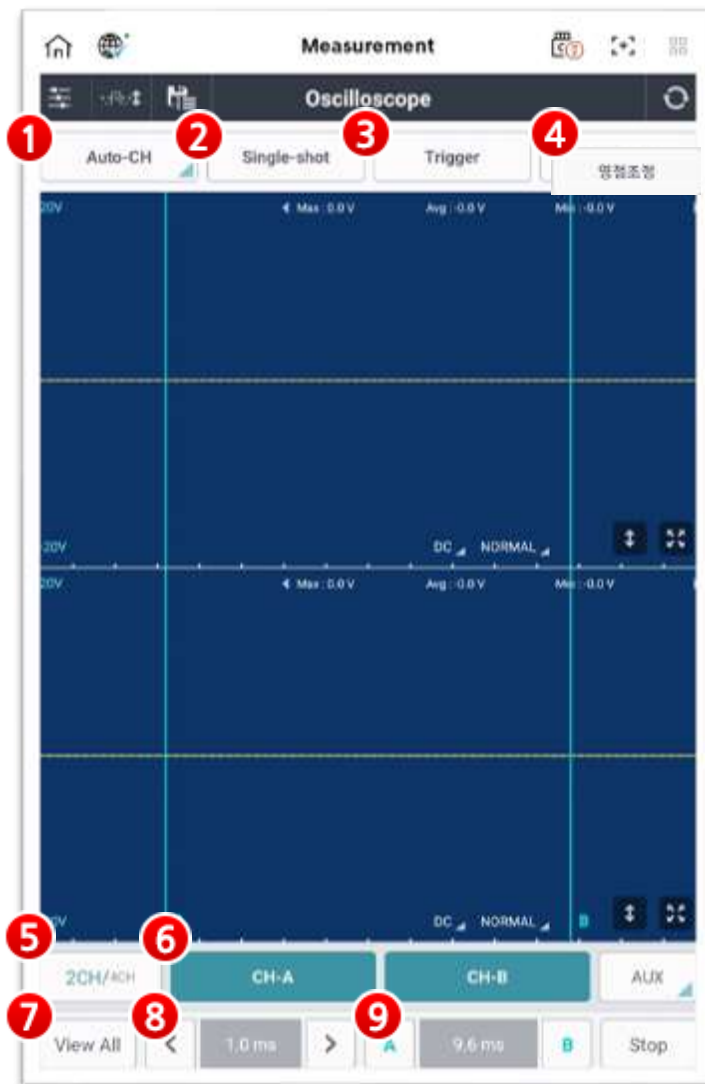

1. Automatic Channel

Automatic Channel function configures a suitable environment for measurement in advance, in order to allow convenient panel inspection of sensor and actuator, which are essential for vehicle diagnosis.

● Individual Setting

The user can configure sensor name and range, etc. for each channel.



● Theme Setting

Theme Setting configures a suitable environment for measurement, in order to allow convenient inspection on sensor and actuator, which should be analyzed complexly.



● User Setting

User Setting allows loading of setting values that are frequently used by the user, apart from the setting values saved in Individual Setting and Theme Setting.

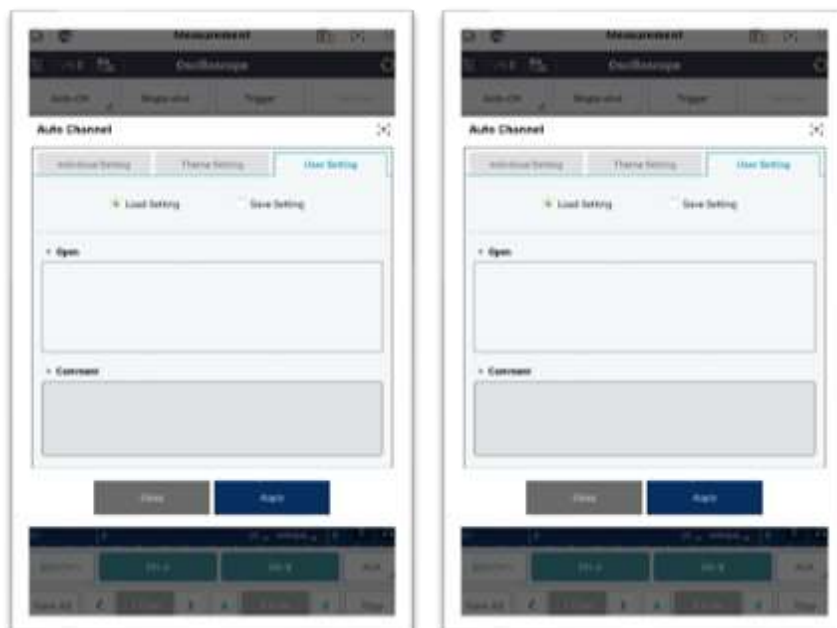

2. Single Shot

Single Shot function automatically stops and indicates the waveform signal if the signal level configured by the user is consistent with the measured signal.

Single Shot mode is used when the user intends to acquire data based on certain time during random occurrence such as APS1 or APS2. It helps the user to more easily identify the waveform change location.

If Single Shot button is selected and a movable trigger cursor is placed in channel area, “Single Shot Start” button is activated. If “Single Shot Start” button is pressed at a desired time by the user, once a waveform that the user intends to record is placed at the desired time, the stopped waveform is output on the screen.



3. Trigger

Trigger function allows the user to touch channel area to display a fixed waveform, which makes the user to easily analyze the waveform.

By touching Trigger icon repetitively, triggers at rising and falling points of the waveform can be fixed and displayed, or the triggers can be removed.

Touch Trigger icon to enter Trigger Mode, touch a trigger point over a waveform you desire to fix, and select the trigger point.

When you select Trigger function, the trigger is made automatically at a rising waveform. If you touch Trigger button again, the trigger is made automatically at a falling waveform. If you touch Trigger button for third time, Trigger function is turned off.

If there are no waveforms at the location configured by the user, “No Trigger” message appears on screen.



4. Zero Adjustment

This function proceeds zero adjustment for accurate measurement when using current (high or low current) sensor and pressure sensor in option function.

5. 2-channel/4-channel

There are total of 5 available channels in VMI, which include 4 channels (CH-A1, CH-A2, CH-B1, CH-B2) and AUX channel.

In 2-channel mode, to measure 2 different signals, CH-A configures one channel and CH-B configures another channel among total of 2 channels (individual ground).

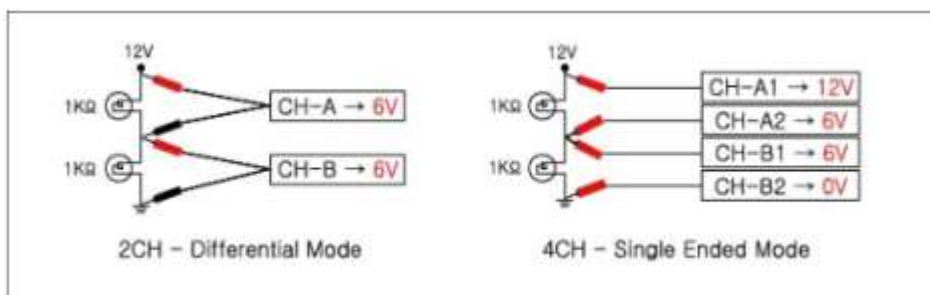
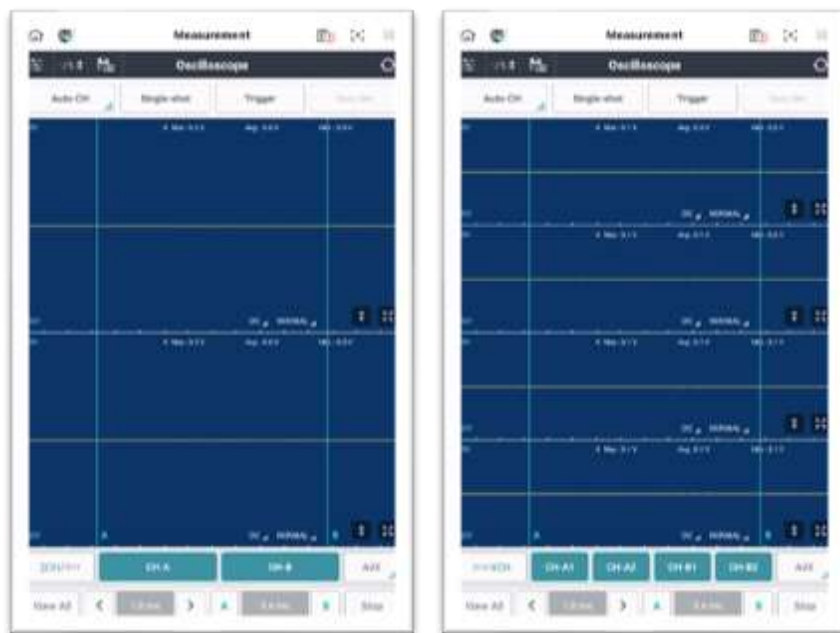

In 4-channel mode, probes of CH-A1, CH-A2, CH-B1 and CH-B2 are used as each channel. Thus, total of 4 channels can be used (common ground), in which case VMI battery cable's (-) clip becomes the ground.



6. Channel & AUX

Each channel can be turned ON/OFF or option function can be used by using the channels and icons at the bottom of screen.

High/low current sensor function can be turned ON/OFF by using AUX icon.

	Function to turn channel A ON/OFF.
	Channel B can be turned ON/OFF, or configured to use the pressure sensor.
	Function to turn high/low current sensor function ON/OFF.



<Channel B>



<AUX>

7. Overlap

For searching or measuring the saved data, all waveforms are overlapped on a single screen so that waveform data can be analyzed easily.

Each waveform color and name are indicated as different colors, so that the user can easily identify them.

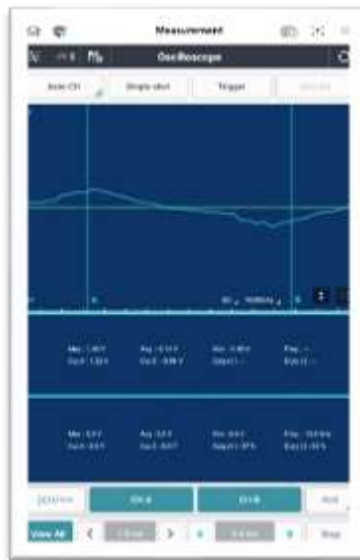





8. Time Scale and Cursor Setting

The waveform can be maximized/minimized by decreasing or increasing the time scale. You can move the cursor to check time difference between cursors.

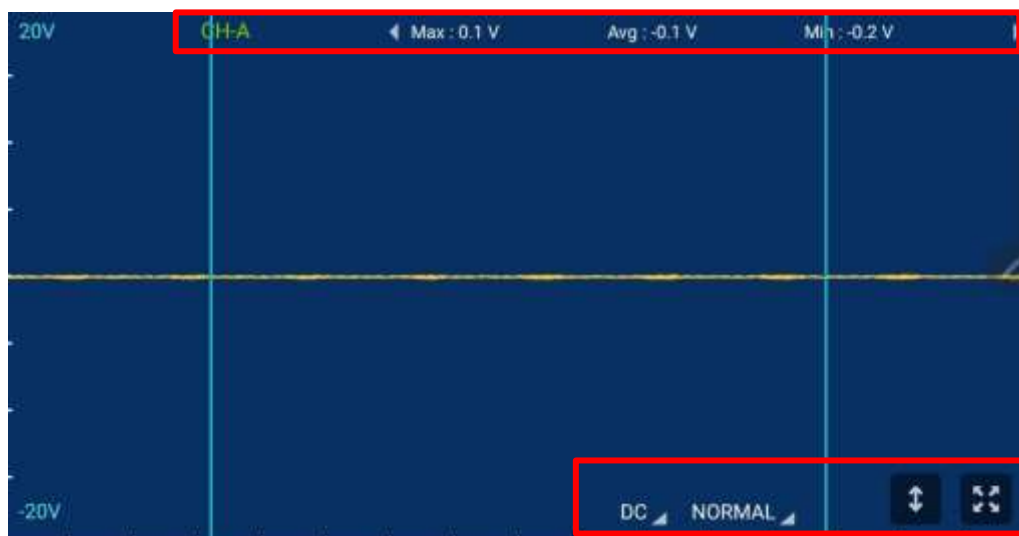
	<p>Ability to control with a specified time axis per section</p>		<p>Set time per section</p>
	<p>Cursor A or B can be activated to move its location. When the cursor is activated, it is indicated as red.</p>		
	<p>It indicates time difference between cursor A and cursor B.</p>		

Screen Description



Top	-	Indicates names and current data that are currently measured on screen.
Bottom	DC	It is used for measuring most of the sensors, and it is the general measurement mode.
	AC	Since vehicle's power is an alternating current that is close to direct current, AC component is present. If DC waveform is placed in AC, the power level is decreased to 0, and the waveform shape is maximized and output. It is used for cases such as when measuring ripple voltage in generator diode, etc.
	NORMAL	This mode measures minimum data for indicating sampling speed (time/section) on screen. In this mode, since is signals such as surge during a short period are not sampled, it is suitable for measuring sensors with low signal output speed such as oxygen sensor or signals of actuator.
	Peak	It is used to neatly and accurately measure surge voltage, which is indicated instantly, such as injector, ignition coil, various solenoid valves, etc.
		It recognizes the waveforms current being output, and automatically changes it into optimum range.
		It configures the range to the user defined range.
		It outputs a selected channel into a maximized screen.
		It reduces the maximized screen to its original size.

Environment Setting

Environment Setting on top left corner of the screen allows adjustment of channel name, range and zero location, etc.

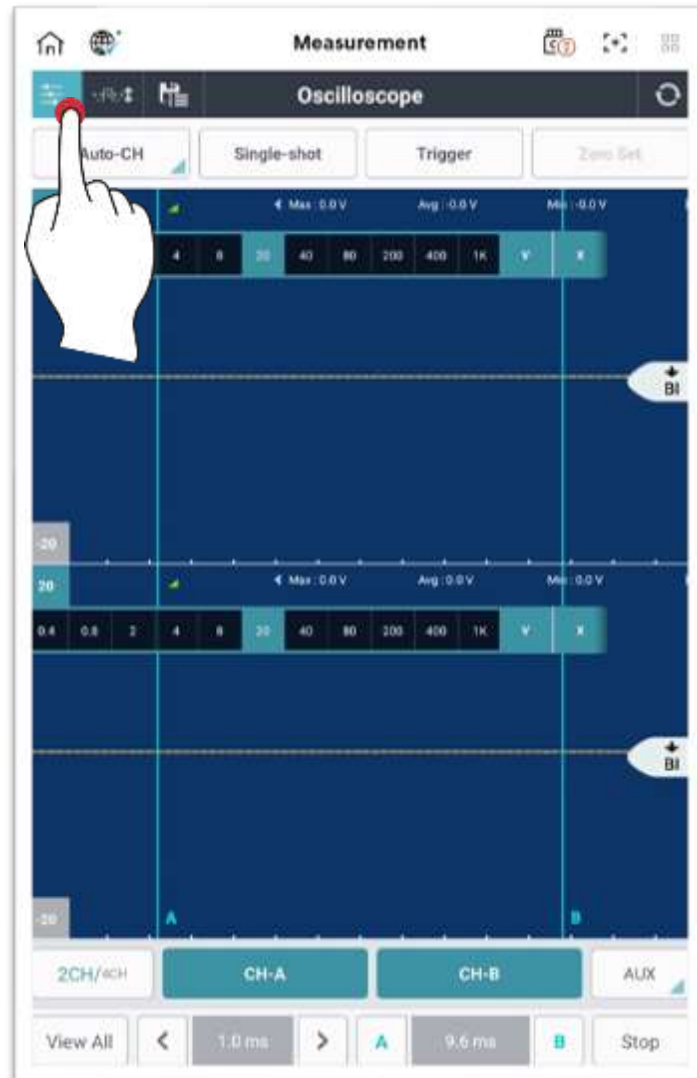

● Channel Name Setting

Channel name can be changed by selecting Channel Name.

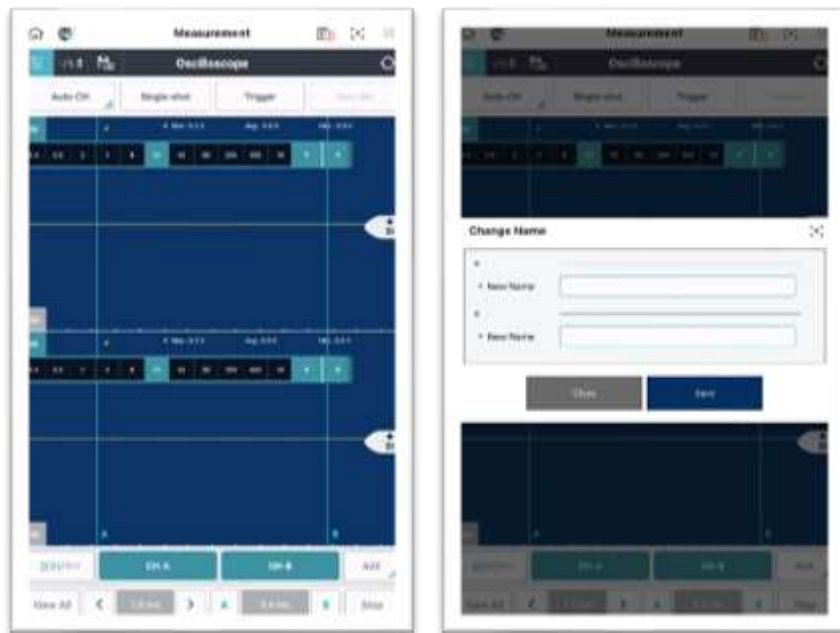

● Range Setting

Measurement range can be configured in accordance with the data being output.



● Zero Location

Zero location can be configured in accordance with the waveform being output.



Auto-threshold Setting

This function adjusts the location of threshold needed for duty value measurement.

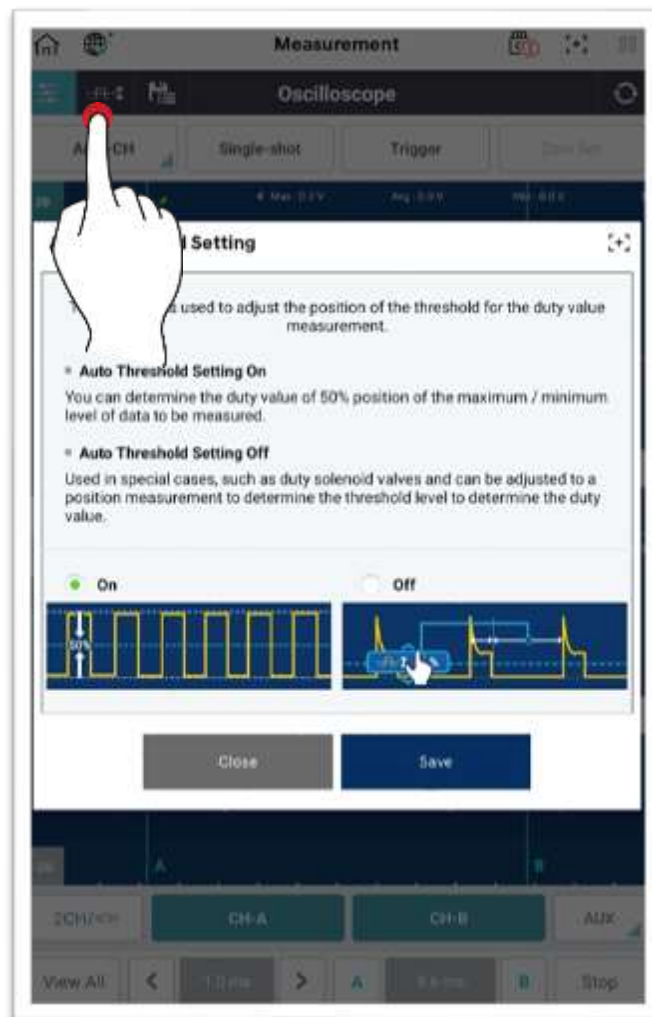

Saving and Loading

If Oscilloscope function is stopped, the output waveform data can be saved.

Use  button on top to load a saved data.

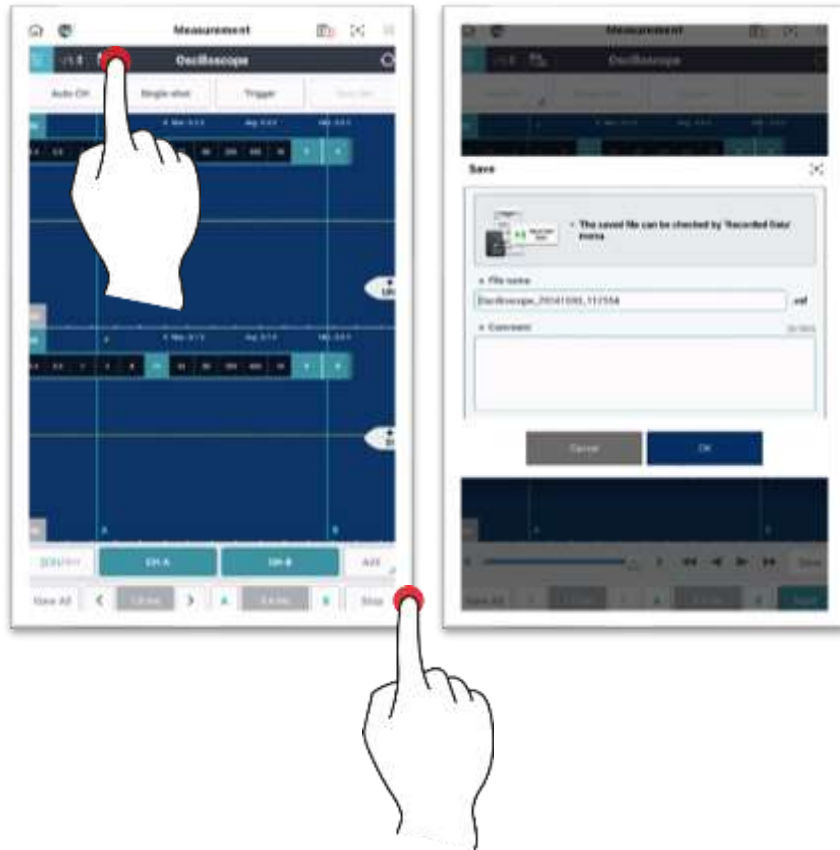

Multimeter

Voltage Measurement

The voltage uses channel B, and it measures voltage difference between (-) probe and (+) probe.

As shown in the figure below, it indicates MAX (maximum value), MIN (minimum value), P-P (maximum value-minimum value) and AVG (average value), which include current value, and the change amount is indicated as a graph at the bottom of screen. When  (refresh) button on top right corner is selected, all data are initialized.



Caution

- ✓ Do not measure 110 V or 220 V alternating current (AC) voltage. It may lead to causing a serious damage to VMI main body.

Resistance Measurement

Resistance uses channel B, and it measures resistance between (-) probe and (+) probe. As shown in the figure below, it indicates MAX (maximum value), MIN (minimum value), P-P (maximum value-minimum value) and AVG (average value), which include current value, and the change amount is indicated as a graph at the bottom of screen. To measure an accurate value, always perform zero adjustment using “Zero Adjustment” function before performing measurement. Connect (+) and (-) probes, and press “Zero Adjustment” button.

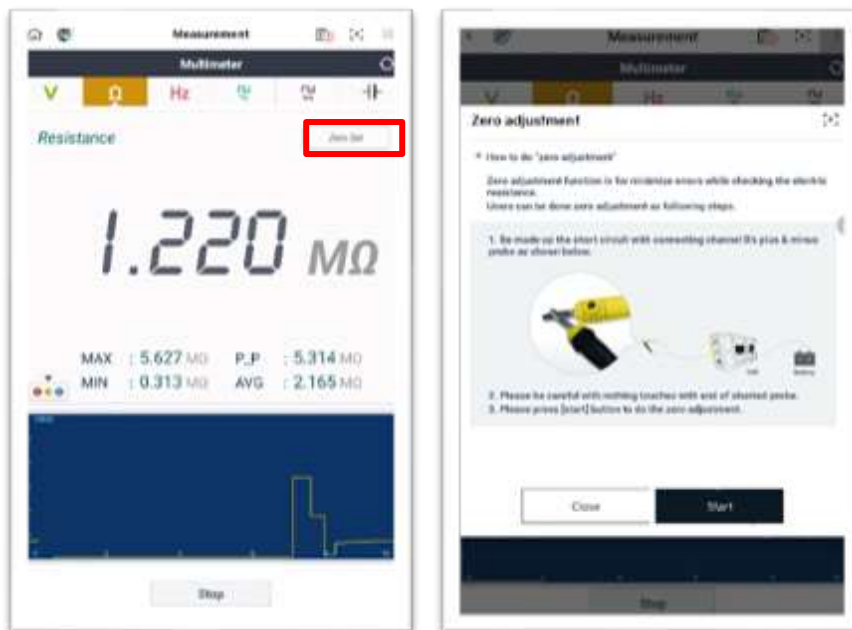

Caution

- ✓ Measure resistance only when the corresponding circuit for measurement is turned OFF.
If power is supplied through channel probe, VMI circuit may be damaged.
- ✓ Since resistance is affected by temperature and channel probe connection status, always perform zero adjustment before measuring resistance.

Frequency Measurement

Frequency uses channel B, and as shown in the figure below, it indicates MAX (maximum value), MIN (minimum value), P-P (maximum value-minimum value) and AVG (average value), which include current value.

Frequency is either indicated as Hz or as number of cycles generated in 1 second. If the display shows 60 Hz, it means that 60 cycles were generated in 1 second.



Caution

- ✓ Measure resistance only when the corresponding circuit for measurement is turned OFF.
If power is supplied through channel probe, VMI circuit may be damaged.
- ✓ Since resistance is affected by temperature and channel probe connection status, always perform zero adjustment before measuring resistance.

Duty Measurement

Duty uses channel B, and its output indicates MAX (maximum value), MIN (minimum value), P-P (maximum value-minimum value) and AVG (average value) for 0% - 100% of (+) duty and (-) duty.

The user can change it to [duty (%)+] and [duty (%)-] to display a desired data.

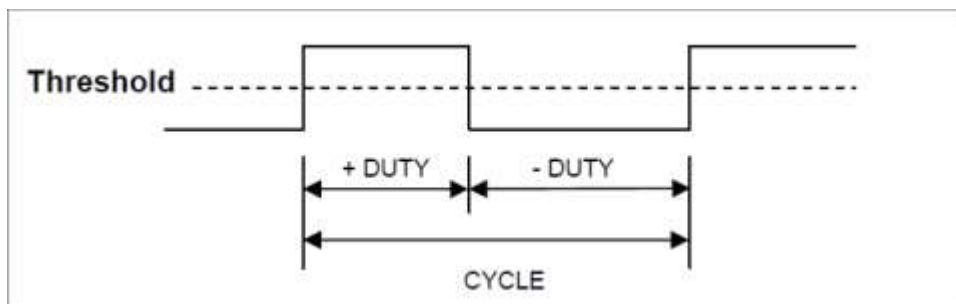

Pulse Width Measurement

Pulse uses channel B, and its output indicates MAX (maximum value), MIN (minimum value), P-P (maximum value-minimum value) and AVG (average value) of (+) pulse width and (-) pulse width.

The user can change it to [pulse width (ms)+] and [pulse width (ms)-] to display a desired data.

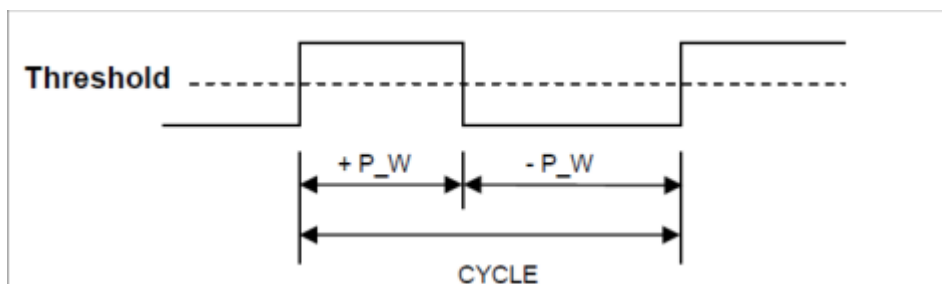

Capacitance Measurement

Capacitance uses channel B, and displays MAX (maximum value), MIN (minimum value), P-P (maximum value-minimum value), AVG (average value) including the current value as shown in the figure below.

Capacitance uses pF as a unit, and outputs a constant constant current to the capacitor (condenser) to measure the voltage increase rate at both ends.



Caution

- ✓ Do not close the test leads while measuring capacitance. This may cause errors in readings.
- ✓ For polarized electrolytic capacitors, connect the red lead to positive (+) and the black lead to negative (-).
- ✓ For accurate measurements, remove and discharge the capacitor separately.

Simulation

Simulation function is used for inspecting operation status of solenoid or sensor circuit, by entering corresponding voltage and pulse in signal line (ECU input terminal) of sensor or controlling duty.

Simulation test for voltage and pulse output can be proceeded by using channel B.
Simulation test for actuator control can be proceeded by using channel A.



Caution

- ✓ If simulation test and operation test are proceeded forcefully, the vehicle's actuator may break down.
- ✓ If the vehicle's solenoid is operated forcefully over a certain period, it may cause negative impact on the vehicle's solenoid.
- ✓ To minimize performance degradation of the vehicle's actuator, simulation and operation test should be completed within a short time.

Voltage Output

Voltage output uses channel B, and a random voltage signal can be output to allow inspection of ECU. Maximum output voltage is 5 V, and input voltage can be adjusted by 1 V or 0.1 V unit by using the arrow key.



Caution

- ✓ Be cautious to prevent probe (+) and probe (-) from being switched each other.
- ✓ During simulation test, if voltage inside the circuit deviates from the range, the indicated value is shown as red text, and the simulation test is stopped.
- ✓ While voltage or pulse output function is performed, the sensor connector should be removed.
- ✓ (once simulation operation is completed, enter Diagnosis for each Code. Then, delete fault codes generated by removing the connector.)
- ✓ **If signal (voltage or pulse output) is entered while the sensor connector is connected, it can be entered together with the sensor signal to ECU.**

Pulse Output

Pulse Output function uses channel B. Instead of a certain sensor signal, frequency (Hz) is transmitted to ECU. Maximum output frequency is 999 Hz, and the input frequency can be adjusted by 1 Hz, 10 Hz and 100 Hz unit by using the arrow key.



Actuator Control

Actuator Control function uses channel A, and this function checks whether operating signal of actuator, which is operated forcefully by the user defined frequency (Hz) and duty (-) and delivered to engine, and the actual operating status of actuator.

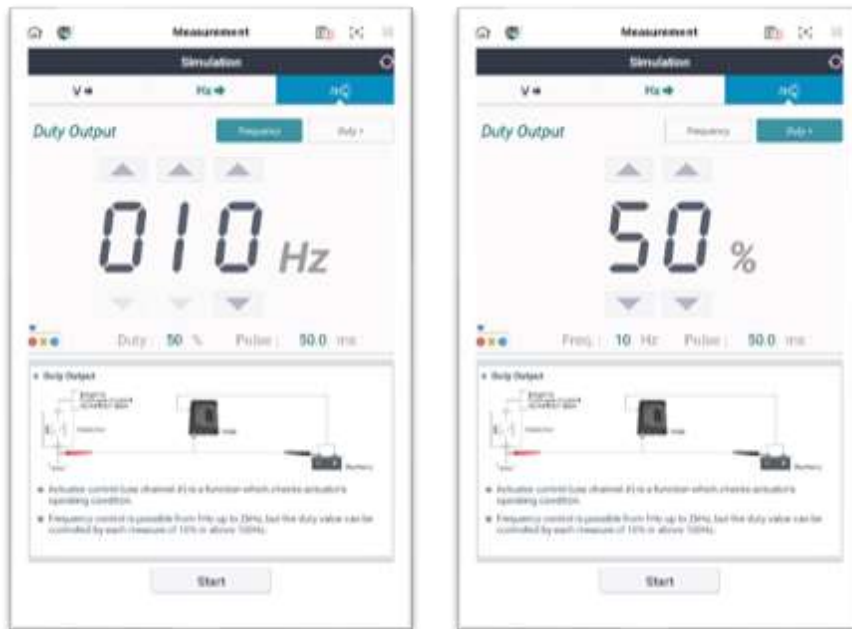

In actuator operation test, input signal is transmitted to control circuit as shown in the figure below.

VMI tests whether the actuator operates properly by transmitting duty signals, instead of ECU transmitted input signals.

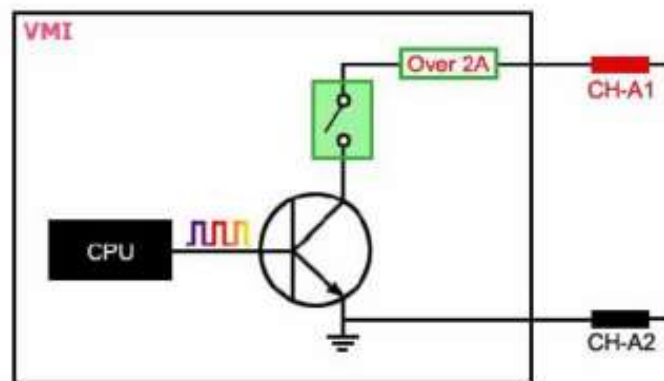

Caution

- ✓ If 2 A or higher current flows in the sensor circuit to be tested, 'Exceeded Allowance Current' pop-up is displayed to prevent circuit damage, and the actuator control function is stopped.

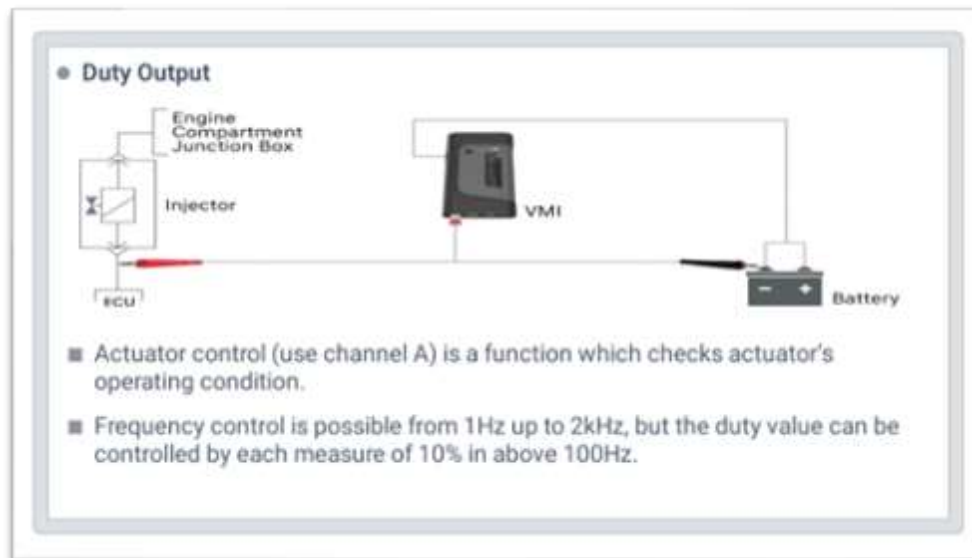

[Product Certification Information and Handling Precautions]

[VMI 3 Label Paper Specification]

- Body



- Battery

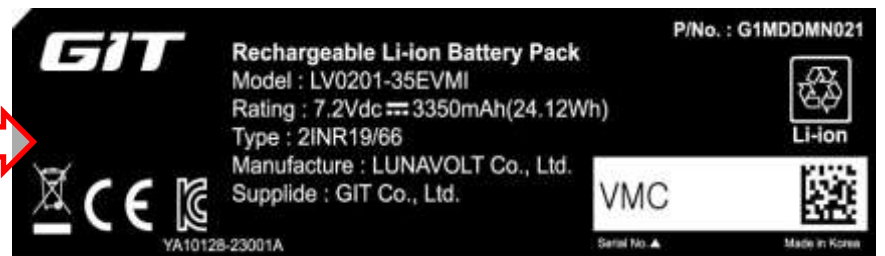

[Cautions for Use]

Disposal of Old Electrical and Electronic Equipment

WEEE (Waste Electrical and Electronic Equipment) symbol shown in [Figure 1] is indicated on the back of the VCI III module body.

Please follow the regulation guide for disposal of Waste Electrical and Electronic Equipment.



Fig. 1. WEEE Symbol

Disposal of Old Electrical & Electronic Equipment (Applicable in the European Union and other European countries with separate collection systems)

This symbol on the product or on its packaging indicates that this product shall not be treated as household waste.

Instead it shall be handed over to the applicable collection point for the recycling of electrical and electronic equipment.

By ensuring this product is disposed of correctly, you will help prevent potential negative consequences for the environment and human health,

which could otherwise be caused by inappropriate waste handling of this product. The recycling of materials will help to conserve natural resources.

For more detailed information about recycling of this product, please contact your local city office,

your household waste disposal service or the shop where you purchased the product.

[Module Certification Information]

Changes or modifications not expressly approved by the party responsible for compliance could void the user's authority to operate the equipment.

This device complies with part 15 of the FCC Rules. Operation is subject to the following two conditions:



(1) this device may not cause harmful interference, and
(2) this device must accept any interference received, including interference that may cause undesired operation. Any changes or modifications not expressly approved by the party responsible for compliance could void the user's authority to operate the equipment.

NOTE:

This equipment has been tested and found to comply with the limits for a Class B digital device,

pursuant to Part 15 of the FCC Rules. These limits are designed to provide reasonable protection against harmful interference in a residential installation.

This equipment generates uses and can radiate radio frequency energy and, if not installed and used in accordance with the instructions, may cause harmful interference to radio communications. However,

there is no guarantee that interference will not occur in a particular installation.

If this equipment does cause harmful interference to radio or television reception, which can be determined by turning the equipment off and on,

the user is encouraged to try to correct the interference by one or more of the following measures:

Reorient or relocate the receiving antenna.

Increase the separation between the equipment and receiver.

Connect the equipment into an outlet on a circuit different from that to which the receiver is connected,

Consult the dealer or an experienced radio/ TV technician for help